

SPECIFICATION OF BSFQ□□□□BNRM SERIES

AEC-Q200



FEATURES

1. SMT designed ferrite/alloy core with magnetic resin coating components for power circuits.
2. High magnetic shielding construction and acted high performance for EMC/EMI protection.
3. Low coil resistance with high current application.
4. Compatible with Pb-free RoHS and AEC-Q200.



APPLICATIONS

- 1 Automotive application

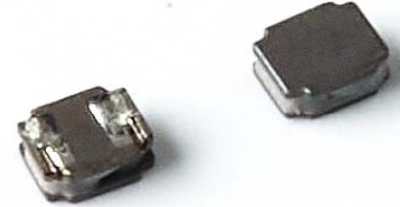

ORDERING CODE

BSFQ2010BNRM 1R0 M T
 (1) (2) (3)(4)

- (1) PRODUCT TYPE CODE AND SIZE CODE
- (2) INDUCTANCE
- (3) INDUCTANCE TOLERANCE (M : ±20%, N : ±30%)
- (4) REEL TAPING

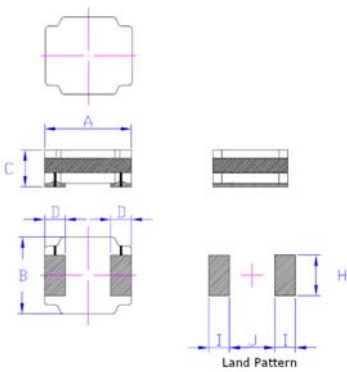

FIG 1

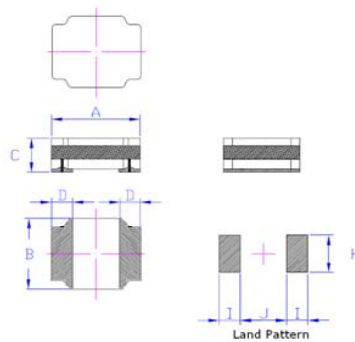

FIG 2

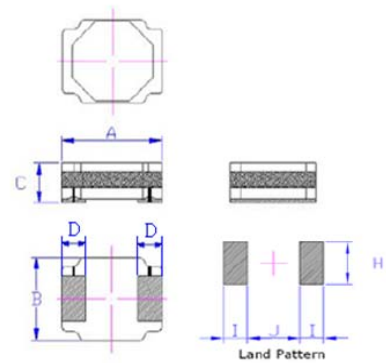

FIG 3

SHAPE & DIMENSIONS

UNIT:mm

SIZE CODE	A mm	B mm	C mm	D mm	H	I	J	FIG				
BSFQ2010BNRM	2.0±0.2	1.6±0.2	1.05max	0.6±0.2	1.10	1.00	0.90	1				
BSFQ2512BNRM	2.5±0.2	2.1±0.2	1.25max	0.85±0.20	1.40	0.95	0.90	1				
BSFQ3015BNRM	3.0±0.2	3.0±0.2	1.55max	0.9±0.2	2.90	1.00	1.20	2				
BSFQ6030BNRM	6.0±0.2	6.0±0.2	3.0±0.2	1.9±0.3	5.70	2.00	2.00	3				
BSFQ6030BNRMX	6.0±0.2	6.0±0.2	3.0±0.2	1.9±0.3	5.70	2.00	2.00	1				

※All the data listed in this catalogue are for reference only, King Core reserves the right to alter or revise the specifications without prior notification.

SMD POWER INDUCTORS → BSFQ2010BNRM SERIES

ELECTRICAL CHARACTERISTIC

ORDERING CODE	Inductance (μH)	DC Resistance (mΩ)max	SRF(MHz) min	Isat (A)max	IDC (A)max
BSFQ2010BNRMR47MT	0.47	57	70	3.30	2.40
BSFQ2010BNRMR68MT	0.68	66	55	2.80	2.30
BSFQ2010BNRM1R0MT	1.00	90	40	2.30	2.10
BSFQ2010BNRM1R5MT	1.50	148	35	1.90	1.50
BSFQ2010BNRM2R2MT	2.20	185	30	1.60	1.40
BSFQ2010BNRM3R3MT	3.30	290	20	1.30	1.00
BSFQ2010BNRM4R7MT	4.70	350	20	1.10	0.90
BSFQ2010BNRM6R8MT	6.80	470	20	0.95	0.88
BSFQ2010BNRM100MT	10.00	850	20	0.80	0.77
BSFQ2010BNRM150MT	15.00	1400	7	0.60	0.46

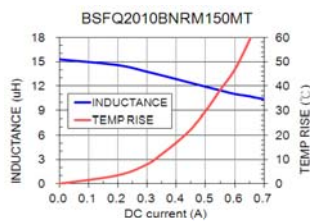
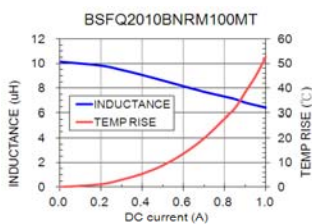
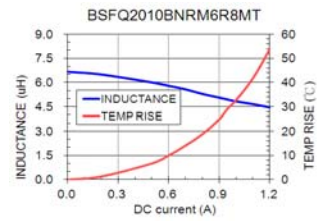
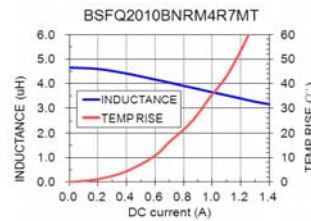
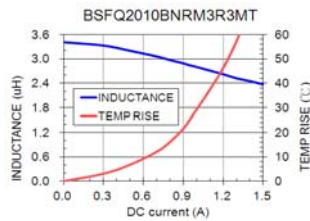
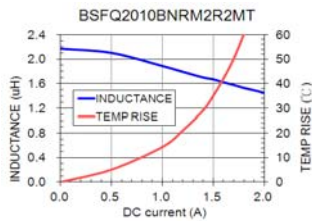
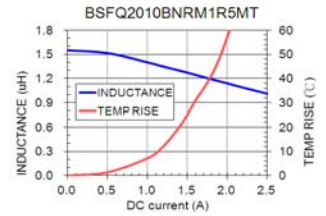
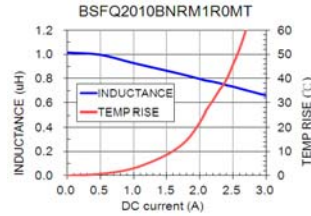
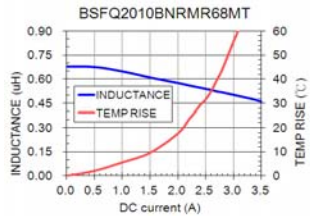
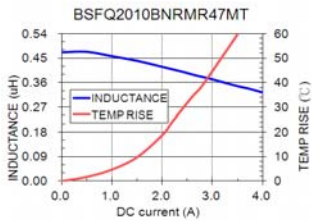

※Test Frequency: 1MHz/0.1V

※Tolerance: M±20%

※Isat: Based on Inductance decrease 30%

※IDC: Based on Temperature increase 40°C

※Operating temperature range : -40 to +125°C (including self-heating)

※Storage Temp. : -40°C TO+85°C

※All the data listed in this catalogue are for reference only, King Core reserves the right to alter or revise the specifications without prior notification.